

## Features

- Narrow Bandwidth
- High Attenuation
- Compact Size
- Surface Mount

## Descriptions

Surface mount ceramic bandpass filter developed for L band applications.

## Electrical Specifications

Parameter	Unit	Specification
Center Frequency (Fc)	MHz	1800
Passband Frequency Range	MHz	1750 ~ 1850
Insertion Loss in Passband	dB	1.0 dB max
Return Loss(VSWR) in Passband	dB	15.0 min
Attenuation	dB	20 min @ DC ~ 1665 MHz
		20 min @ 1925 ~ 2825 MHz
Power Handling	dBm	20 CW max
IN/OUT Impedance	Ohm	50
Operating Temperature	°C	-40 ~ +85
Dimensions	mm	14 x 13 x 5.5 (W x D x H)
RoHS	-	Yes

## Mechanical Drawing

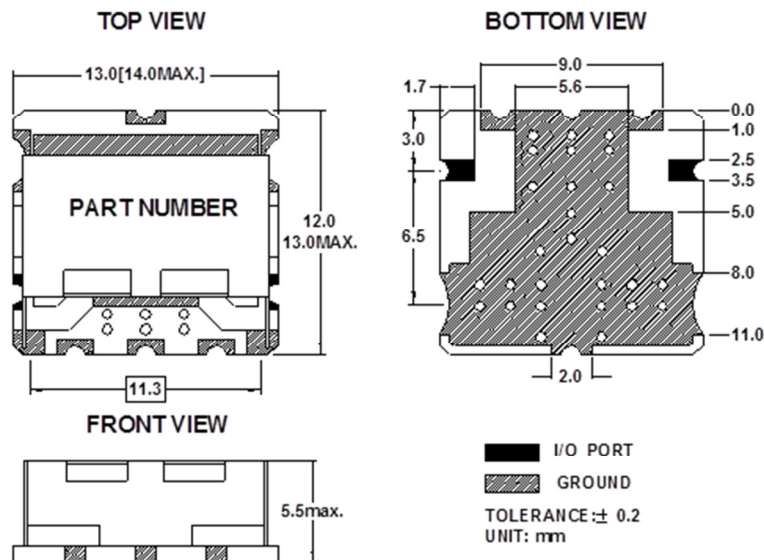

## Electrical Response

