

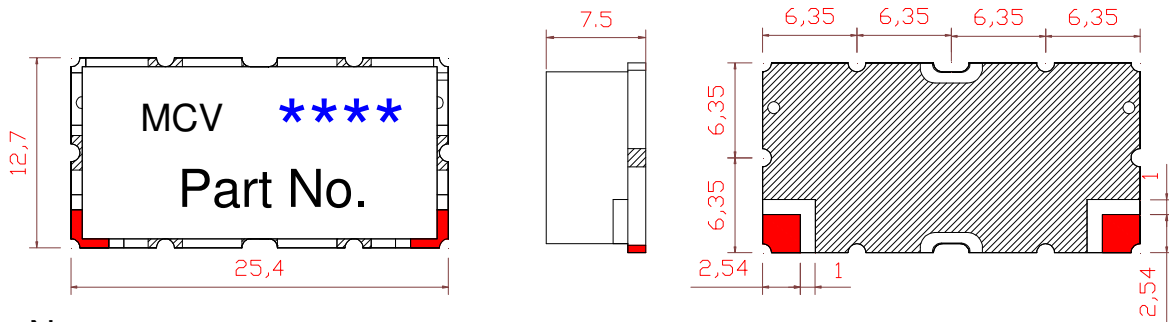

Electrical Specifications

No.	Parameter	Unit	Specification
1	Cutoff Frequency	MHz	42
2	Bandwidth	MHz	DC ~ 42
3	Insertion Loss in BW	dB	1.0 max
4	Ripple in BW	dB	1.0 max
5	Return Loss in BW	dB	15 min
6	Attenuation	dB	60 min. @ 108MHz
7	Input Power	W	1W max
8	In / Out Impedance	Ohm	50
9	Operating Temp.	°C	-20 ~ +70
10	RoHS	-	Yes

Dimensions (unit: mm)



Notes :

1. Surface mount package
2. Dimensions in millimeters
3. Max reflow temperature 230°C for 10 sec
4. If boards are cleaned after installation units must be completely dried
5. Tolerance unless specified : ± 0.3
6. **** -> Date code(YYWW)

- : In / Out Port
- : Ground
- : No metal



Simulation

